

OPTICS11 LIFE

LIFE SCIENCE INSTRUMENTS

QUANTIFY MECHANICS IN BIOLOGY

Kevin Bielawski
06 Jul 2023

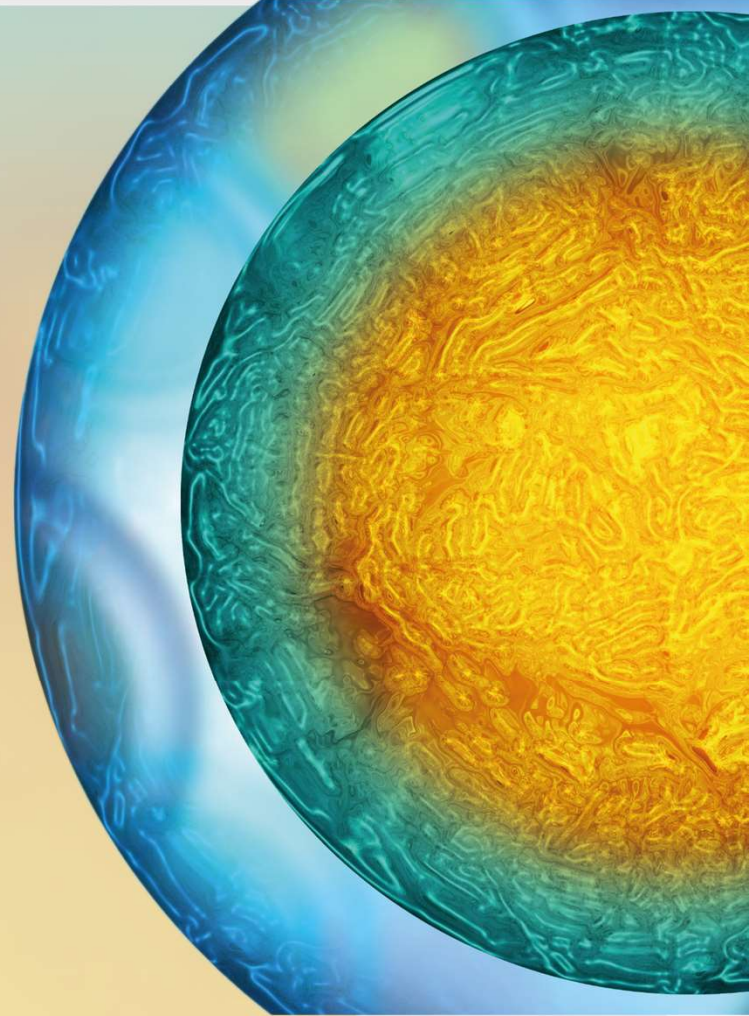

OVERVIEW – OPTICS11 LIFE

- > Amsterdam, Boston
- > Founded in 2011 – now two companies – Optics11 and Optics11 Life
- > Spinout from Vrije Universiteit Amsterdam
- > 120+ Customers, 200+ Publications
- > Nanoindenters – Piuma, Chiar, Pavone
- > Contractility – Cuore
- > Soft materials in liquid – cells, biomaterials, tissues, organoids, spheroids

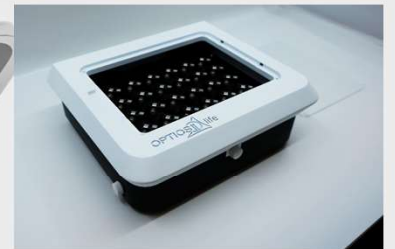
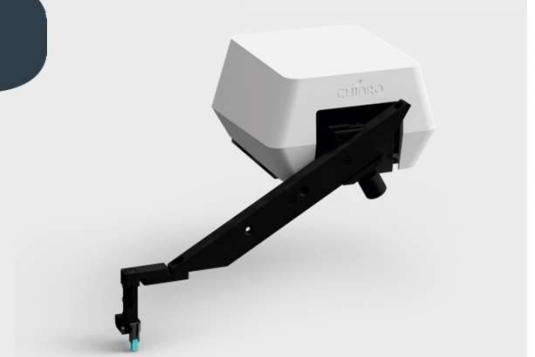
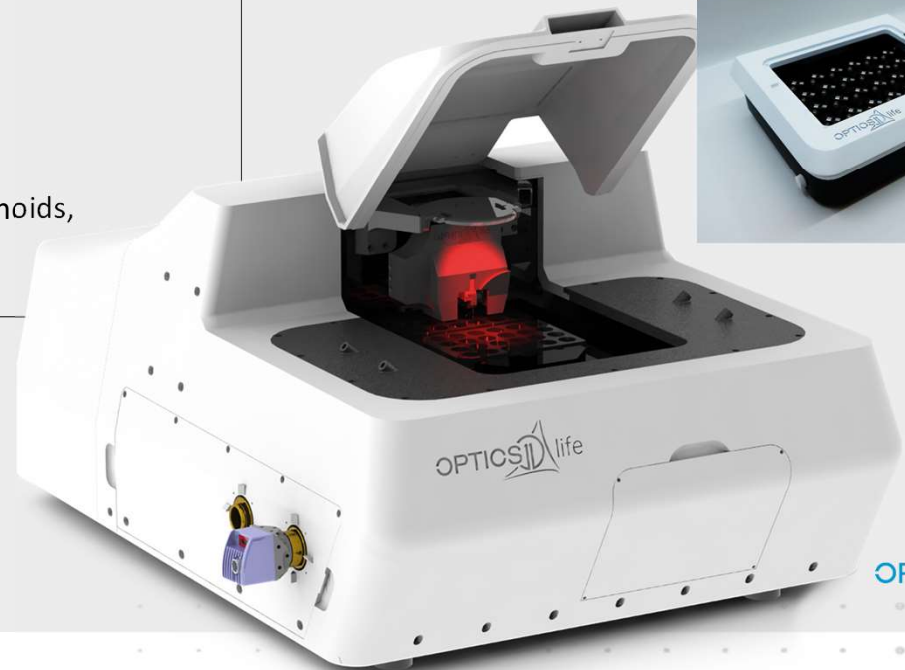

OPTICS11 LIFE INTERROGATORS

OP1550



DeltaSens

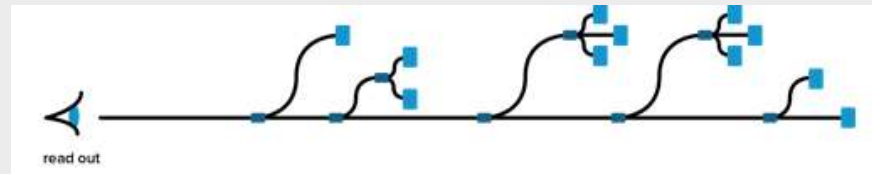
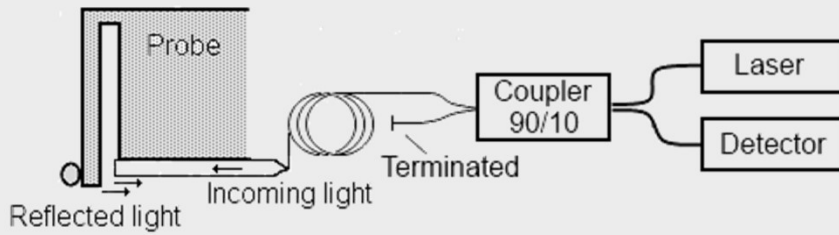

OPTICS11 LIFE PROBES

A unique fiber optic probe

- > Optical Interferometry – FP cavities
- > Silicon Cantilever, Glass Sphere
- > Any medium or in Air
- > Pre-calibrated, reusable

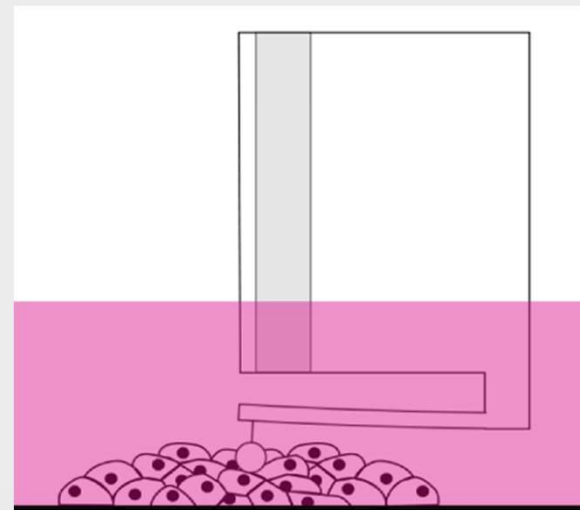
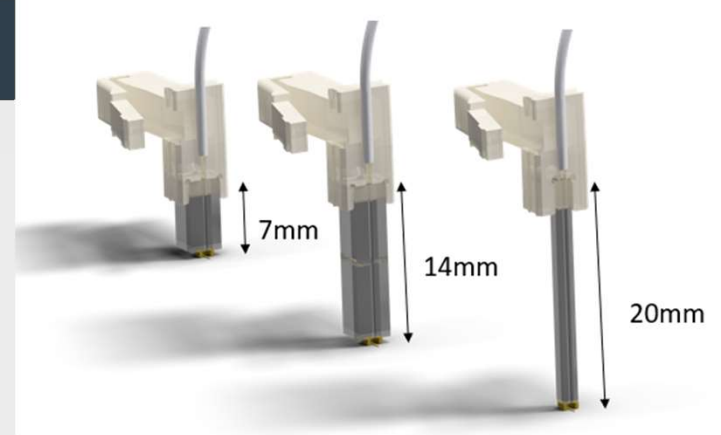

NANOINDENTATION

1 OPERATE

Combine any mode of operation.

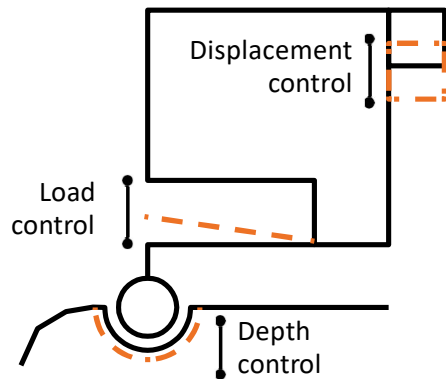

2 INDENT

INDENT

With any indentation profile.

Quasi-static profile



Dynamic oscillatory profile

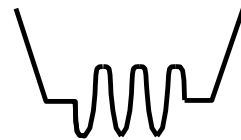

3 MEASURE

MEASURE

Measure the mechanical properties.

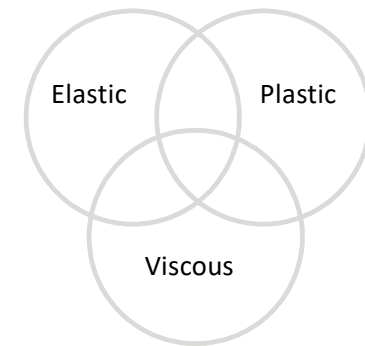

MAPPING CAPABILITIES

Mapping Topography and Stiffness

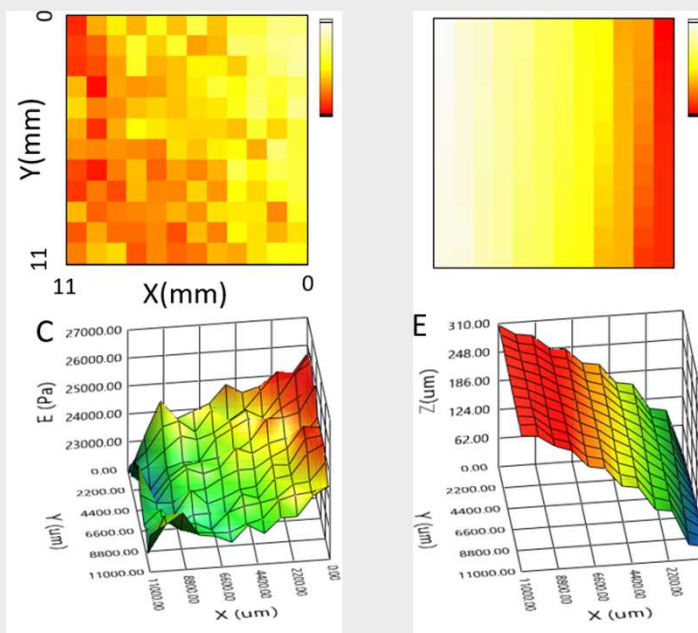

Organoid mapping

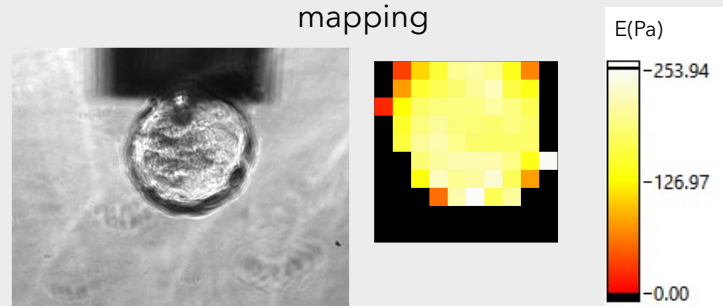

PAVONE – SELECT POINTS OF INTEREST

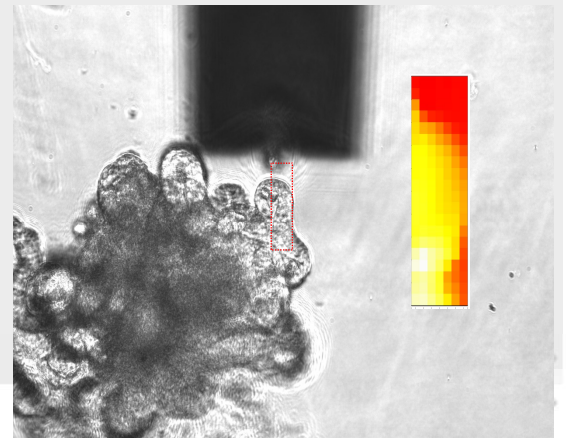
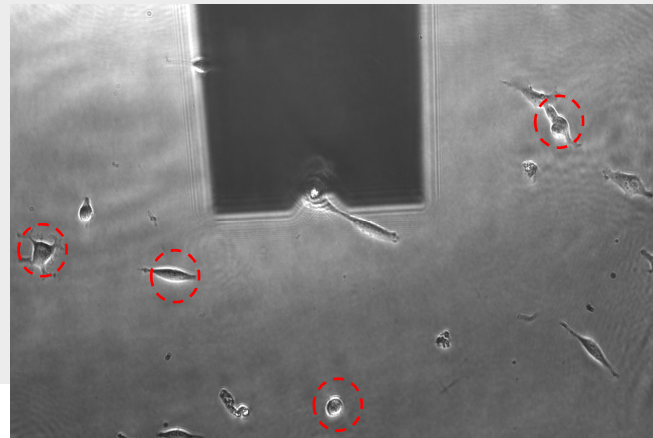
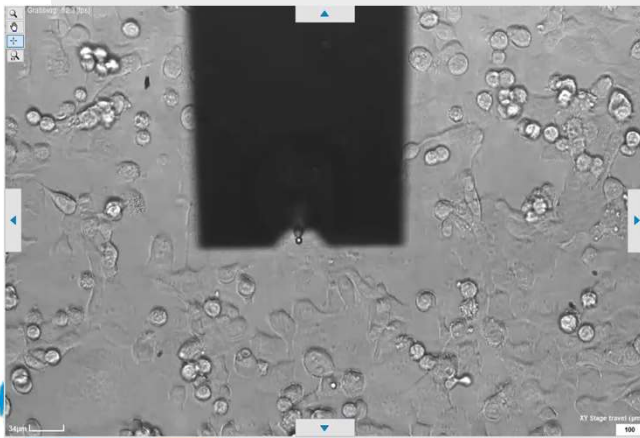
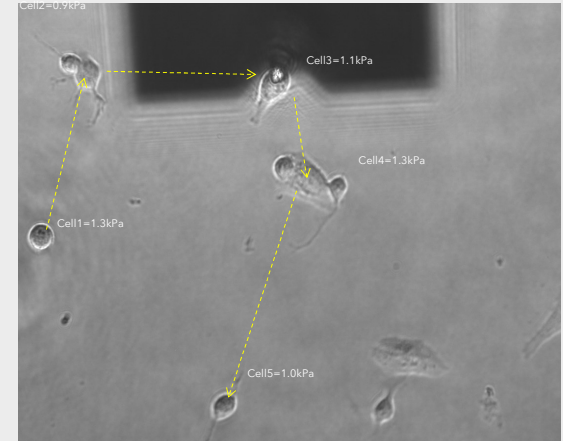
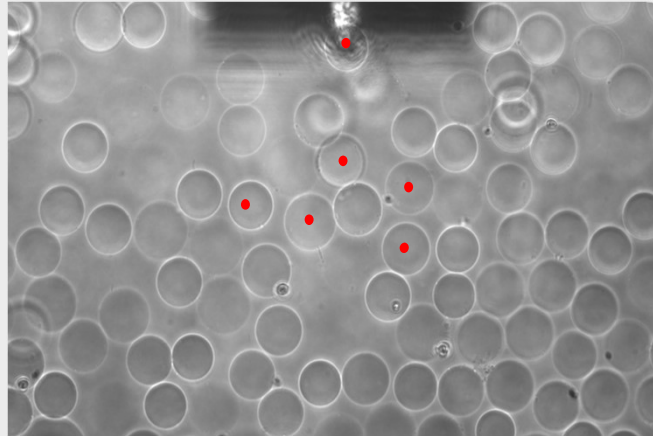
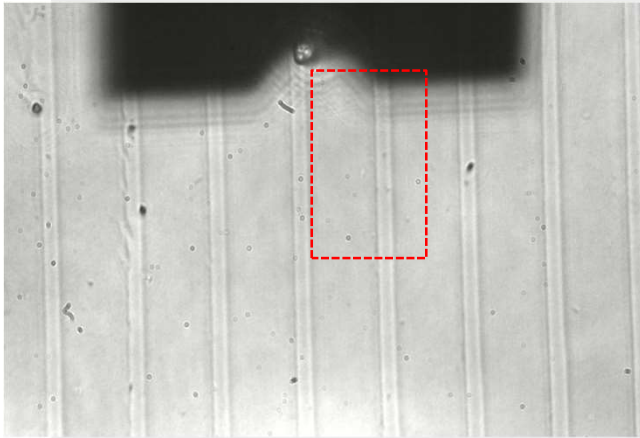

DYNAMIC MEASUREMENTS

MAP MECHANICAL PROPERTIES

- > 96 well plate compatibility (Pavone)
- > Young's modulus (loading + unloading)
- > Storage & Loss Modulus
- > Stress Relaxation
- > Creep
- > Adhesion

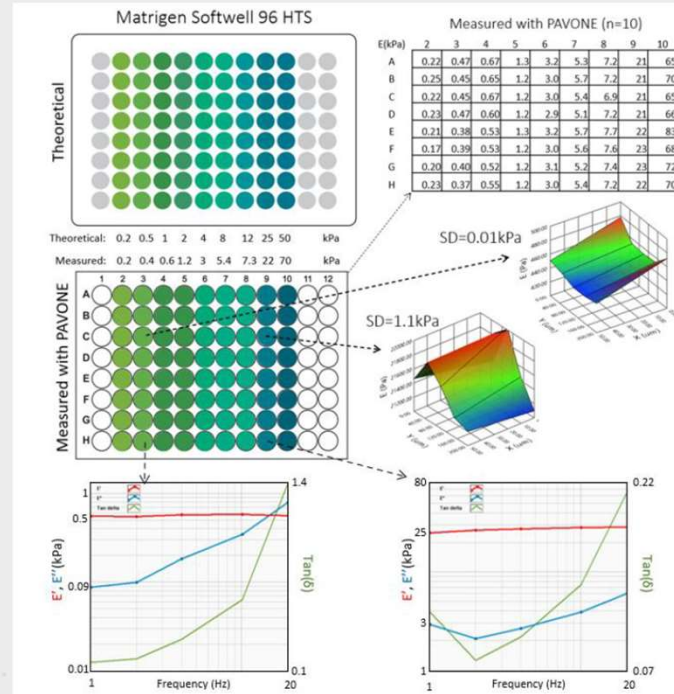
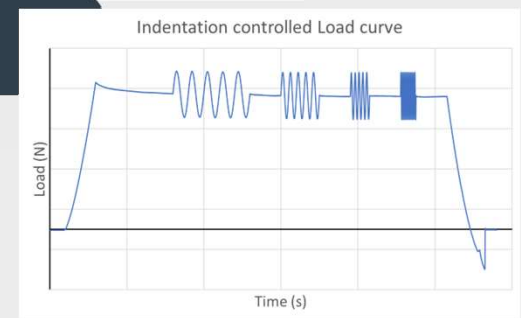

CUORE – CONTRACTILITY ASSAY

3D multi-channel muscle force assay

- > 3D engineered cardiac or skeletal muscle bundles
- > Mature & measure multiple tissues in parallel
- > Monitor real-time inside incubator
- > Read-out 24 tissues
- > Pacing up to 96 tissues in parallel

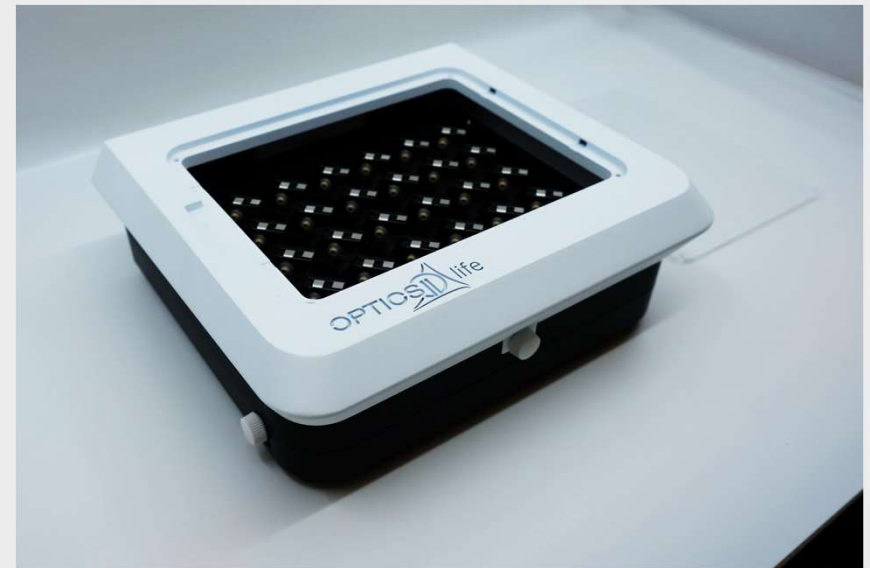
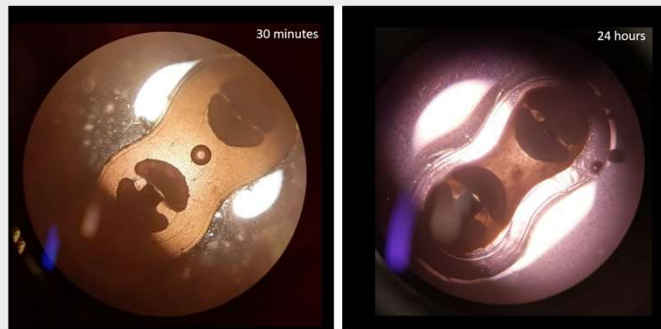

CUORE – CONTRACTILITY ASSAY

FIBER-OPTICAL READ-OUT

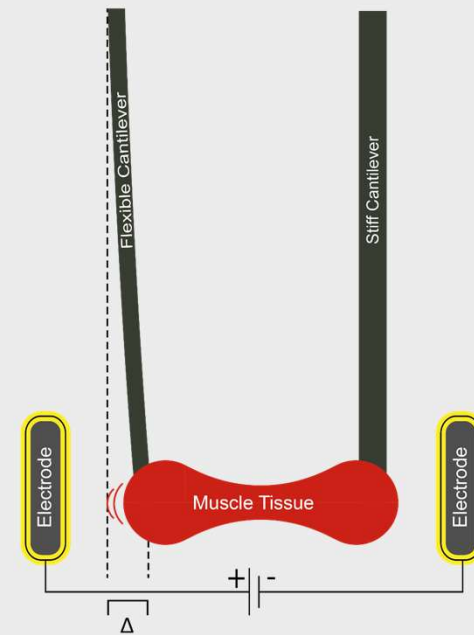
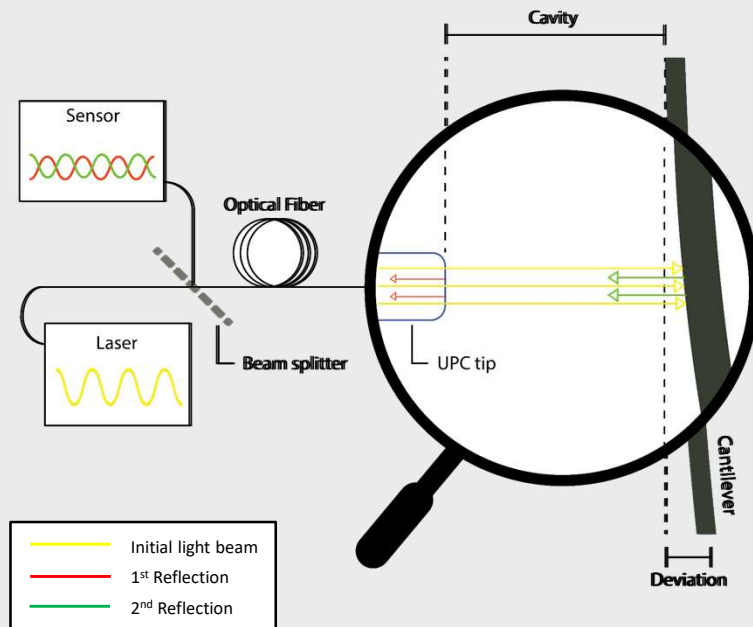

CUORE – CONTRACTILITY ASSAY

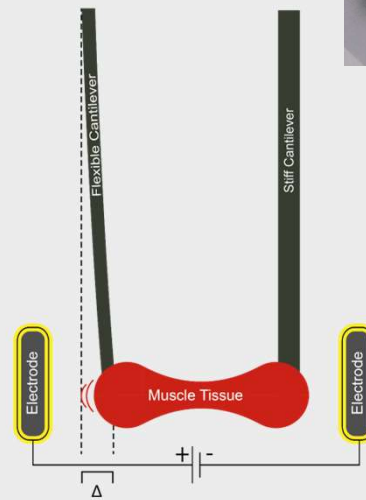
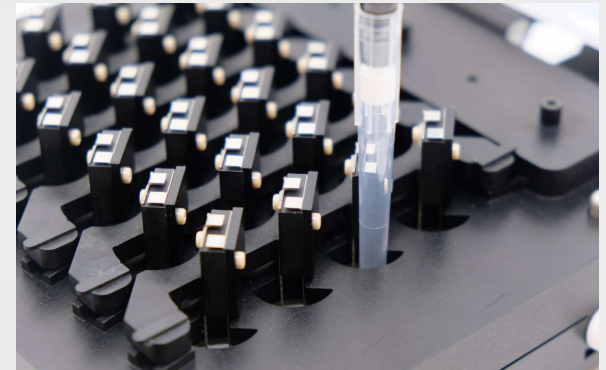
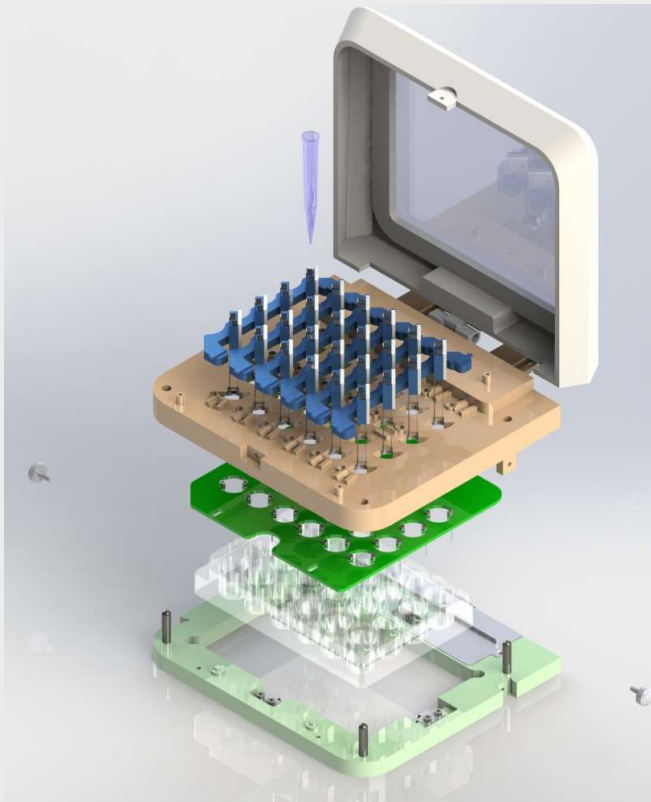

COMPANY INFO

Headquarters (Europe)

Hettenheuvelweg 37-39,
1101 BM Amsterdam
[+31 20 809 6000](tel:+31208096000)

USA office

One Broadway 14th floor
CIC Cambridge MA02142
USA
857 231-2075

